

NIS #Q225-1

DMS-100 Family

Speech Activated Intelligent Dialing
SAID
(NTXR25AA)

Northern Telecom Interface Specification
for DMS Network Interface Access to
Intelligent
Peripherals, Volume 1 of 2

Version 1.1 February 1995
Price: \$150.00 U.S.

NIS #Q225-1
(c) Copyright 1995 Northern Telecom



DMS-100 Family

Speech Activated Intelligent Dialing
NFA (NTXR25AA)

DMS-100 Network Interface to Intelligent Processors Specification
BCS 35

NIS #Q225-1

Draft Version 1.0
July 1994

Version 1.0
August 1994

Version 1.1
February 1995

Copyright 1995 Northern Telecom LTD.
All Rights Reserved

Table of Contents:

1.1	Summary	6
1.2	Types of Access	6
1.3	Implicit Operation	6
1.3.1	SAID Subscriber Connects to IP Using Implicit Protocol.	6
1.3.2	Restricting Implicit Access	8
1.4	Explicit Operation	8
1.4.1	SAID Subscriber Connects to IP Using Explicit Protocol	8
1.4.2	DP to DTMF Conversion After Explicit Access	9
1.5	Remote Access Operations	9
1.6	Implicit, Explicit, and Remote Access IP Dialing	10
1.7	Combination of Implicit/Explicit/Remote Access	11
1.8	INTERACTIONS	11
1.9	Digit Stringing	14
1.10	SAID Hardware Characteristics	15
1.10.1	SAID NFA Trunk Characteristics	15
Figure 1	- Implicit Connection, Subscriber Dials the Call	17
Figure 2	- Implicit Connection, IP Dials the Call	18
Figure 3	- Explicit connection, Basic DP/DTMF Conversion Performed	19
Figure 4	- Implicit Connection Followed by Explicit Connection	20
Figure 5	- IP dialing SAID Explicit Feature Access Code	21
Figure 6	- Remote Access with IP Dialing	22
Figure 7	- Remote Access with IP Dialing, CFRA Present	23
Figure 8	- Subscriber Flash Placing IP on Hold	24
Figure 9	- Extended Conversion on an Explicit Connection	25
References		26
Glossary of Abbreviations		27
Feature Description- SAID		29
DMS to IP NFA Trunk Timing Diagram		30
SDL for NFA Implicit and Explicit Connections		31

NOTICE PAGE

Northern Telecom makes no representation in respect to and does not warrant any of the information in this Specification, but furnishes such in good faith and to the best of its knowledge and ability. Without restricting the generality of the foregoing, Northern Telecom makes no representations as to fitness for a particular purpose, or as to whether or not the use of the information in the Specification may infringe on any patent or other rights of any other person. The recipient waives any claims it may have against Northern Telecom in respect of any use which the recipient makes of the information or product derived therefrom. It is expected this Specification will be revised in the future to reflect DMS-100 and DMS-100/200 service and feature enhancements. Northern Telecom reserves the right to alter or modify this Specification or the equipment to which it relates at any time without notice and without liability.

This specification is provided as a guide for network planners and suppliers of systems or equipment designed to meet the requirements of Northern Telecom's Speech Activated Intelligent Dialing (SAID) Interface Specification. Northern Telecom reserves the right to revise the contents of the guide for any reason, including, but not limited to, conformity with standards promulgated by any public standards agency, advances in technology, or to reflect changes in requirements of communication networks, system or applications. The provision of any capabilities described in this document is dependent on certain business decisions, resolution of which may also result in changes to withdrawal of, or addition to, any or all of the capabilities herein.

DMS-100 and DMS-100/200 are trademarks of Northern Telecom.

To order the latest version or additional copies of this document, DMS-100 Northern Telecom Interface Specification (NIS Q225-1), you may call 1-800-347-4850 (option 2) from 8:00 AM to 5:00 PM Eastern Time.

Outside of these hours this line will be served by an answering machine or you may write to:

Northern Telecom Inc.
Merchandising Ordering Specialist
Dept. 6611
P.O. Box 13010
Research Triangle Park, NC 27709

REVISION HISTORY

Preliminary Draft Version
July 1994

Version 1.0
August 1994

Version 1.1
February 1995

1.0 Summary

Speech Activated Intelligent Dialing (SAID) provides the communications protocol between a DMS 100 or 100/200 switch and voice-dialing intelligent peripheral (IP). SAID allows a subscriber to voice dial a call.

A subscriber accesses the SAID feature from his telephone set. The DMS switch establishes a connection between a subscriber and a trunk, which connects to an Intelligent Peripheral. A speech path is created between the subscriber and IP. The subscriber speaks with the IP; The IP uses voice recognition to match the spoken phrase with a digits template. The IP then signals the DMS that it wishes to send digits for the subscriber. The DMS places the subscriber on hold and the IP sends digits to the DMS switch. The DMS switch completes the call as if the subscriber dialed the digits. Any call initiated by the IP dialing is handled as if the subscriber himself had dialed the digits. The IP may dial a routable number, as well as a feature access code.

SAID uses a Network Facility Access (NFA) trunk to connect the IP to the DMS. The NFA trunk is a standard interoffice DS-1 digital trunk. This trunk will only support terminations; call originations from the IP over this trunk are not supported. Standard in-band signaling is used over the trunk connection.

SAID allows the subscriber to use an implicit or explicit access to dial routing directory numbers (which terminate to lines and trunks) as well as feature access codes. Whenever a feature access code is dialed by an SAID connection, the feature is invoked just as it would be if the subscriber had dialed the feature access code from his telephone line. If the activated feature requires that additional digits be dialed by the subscriber, then the subscriber must dial the digits manually from his telephone set.

Functionality described in this document requires NTXR25AA BCS 35 DMS software unless otherwise noted.

1.1 Types of Access

SAID provides three different types of access for a subscriber: Implicit, Explicit, and Remote.

1.2 Implicit Operation

A subscriber with an active implicit option is connected to the IP every time he goes offhook. Modes of access are controlled via line datafill.

An implicit access to an NFA trunk can be established for a subscriber each time the subscriber goes offhook from his telephone set. The subscriber may voice dial using the IP or dial normally. The subscriber may activate and deactivate SAID implicit access by entering a feature access code that acts as a toggle.

1.2.1 SAID Subscriber Connects to IP Using Implicit Protocol.

- (1) The subscriber goes offhook. Upon offhook, the DMS first provides normal dial tone to the subscriber, and starts the receiver offhook (ROH) timer.

- (2) The subscriber's line is connected to both the IP and a digit receiver upon every origination. The IP is used for voice dialing, the digit receiver for normal keypad dialing. Dial tone is removed after an IP connection. The digit receiver may be a Digitone (DTR) Receiver, or a Universal Tone Receiver (UTR.) A receiver is utilized only if the line uses Dual-Tone-Multi-Frequency (DTMF) signaling; Dial Pulse (DP) lines do not require a digit receiver.
- (3) The DMS uses routing information datafilled in the line's customer group data to determine which trunk group to seize to connect to the IP. If there are no idle members of that trunk group, an existing trunk Operational Measurement (OM) is pegged, and the connection attempt is aborted. The subscriber will not receive an implicit access in this situation, but retains his dial tone, and may make calls as normal. If there is an idle member of the trunk group, it is seized, and then the implicit service code and subscriber id for the line is outpulsed to the IP. These values are datafilled in the line data.
- (4) The DMS attempts to seize an idle NFA trunk. If no trunk is available, the subscriber retains dial tone and can dial the call normally. If a trunk is seized, the DMS waits the amount of time specified in an internal table. This parameter can be set from 0 to 150 milliseconds. Note: in NA004 this parameter can be set from 0 to 640 msec with a default of 150 msec.
- (5) The service code can be up to five digits in length. The service code is datafilled in the DMS switch based on the type of access (implicit, explicit, or remote.) The user id is assigned on a per-line basis and is typically the directory number of the subscriber.
- (6) The DMS is now awaiting answer supervision from the trunk.
 - (a) If answer supervision is received from the trunk, The DMS removes dial tone from the line, and sets up a two-way voice path between the subscriber and the IP. The subscriber now hears whatever the IP provides over the voice path.

Answer supervision can be sent by the NFA trunk before the DMS finishes outpulsing digits. However, the DMS will not recognize and process the answer supervision until all of the service code and ushered digits have been outpulsed.

After the DMS detects answer supervision from the NFA trunk, the DMS sends an inverted wink to the IP over the NFA trunk. This cut-through inverted wink can be 50 to 100 milliseconds in length.

An inverted wink is similar to a normal wink; however, the state changes are inverted (i.e. a normal wink is a state change from onhook to offhook, and back to onhook, while an inverted wink is a state change from offhook to onhook, and back to offhook.)

- (b) If the answer is not received from the trunk within a time datafilled in the trunk's group data, the trunk is released, and the subscriber retains normal call processing ability (his dial tone would have never been removed.)

- (c) If the subscriber goes onhook or flashes the line, the DMS will then drop the trunk connection. Note that this may occur before or after answer is received from the NFA trunk.
 - (d) If the IP goes onhook (after sending answer supervision to the DMS, and before dialing a number for the subscriber), the trunk connection is dropped, and the DMS applies new dial tone to the subscriber, who can now call process as normal. This tone is a normal steady dial tone. The ROH timer is also reset at this time.
 - (e) If the subscriber dials a digit, the trunk is released (or, if the subscriber dials a digit before the trunk connection has been completed, the connection attempt is aborted.) Normal call processing now occurs for the subscriber. The first digit dialed by the subscriber is reported to the DMS, so that disconnection of the IP may proceed as quickly as possible, to prevent the subscriber from hearing anything from the IP while he is dialing.
- (7) Following (6) (a) above, the subscriber can speak to the IP.
- (8) The subscriber retains the ability to dial digits throughout the duration of an implicit connection until the IP sends the IP-dial inverted wink described below.
- (a) The subscriber can speak to the IP. If the IP decides it wants to dial a number, it sends the DMS an inverted wink over the NFA trunk. This IP-dial inverted wink must be 60-210 milliseconds in length.
 - (b) If the ROH timer expires without any of the above events occurring. The subscriber receives standard reorder treatment, and the IP connection is dropped.

1.2.2 Restricting Implicit Access

Switch line datafill controls SAID subscriber's implicit access. A subscriber can have any combination of implicit, explicit, or remote access.

1.3 Explicit Operation

1.3.1 SAID Subscriber Connects to IP Using Explicit Protocol

A subscriber dials a pre-defined feature access code to establish an explicit access to an NFA trunk.

A subscriber with the explicit option hears dial tone when he goes offhook. He may dial the explicit feature access code and receive an explicit connection to the IP.

From this point, the protocol is the same as for implicit access, except for the following:

- (1) If an idle NFA trunk member is not available, the subscriber receives reorder treatment. With implicit access, the subscriber retains dial tone.

If the IP fails to answer within a time datafilled in trunk's group data, the trunk connection is dropped, and the subscriber receives treatment. With implicit access, the subscriber retains dial tone.

- (2) Dial tone is removed from the subscriber's line as soon as they dial the NFA explicit access feature access code.
- (3) Any digits the subscriber dials after making an explicit connection will be sent to the IP after the IP answers and the DMS sends the IP the cut-through inverted wink. Digit collection by the switch on the subscriber's line stops after the IP answer.
- (4) Any dial-pulse digits dialed by the subscriber are converted to DTMF digits before being sent to the peripheral.

1.3.2 DP to DTMF Conversion After Explicit Access

DP to DTMF digit conversion is provided to convert DP digits entered from a subscriber dial-pulse (rotary) phone to DTMF digits before these digits are outputted to the IP. A subscriber's method of conversion is controlled through DMS translations.

1.4 Remote Access Operations

Remote access to SAID provides the SAID subscriber with the capability to access an NFA trunk from other locations in addition to his base telephone line. This is accomplished by defining a directory number which will allow him to access his home DMS switch via the Direct Inward System Access (DISA) feature package. A DISA option indicates that the number can be used for remote SAID access. Once a caller to this DN has been authorized, a remote connection is established between the caller and the IP. This remote connection utilizes the same signaling protocol which is used for an explicit SAID connection.

If the subscriber has been authorized for remote access to SAID, a remote connection to the IP is established via the NFA trunk by outputting the remote access service code datafilled for the customer group along with the subscriber's user id. The caller has access to IP functionality compatible with a remote access.

1.5 Implicit, Explicit, and Remote Access IP Dialing

This section explains what happens after a subscriber connects to the IP and voice dials. The protocol is the same, with noted exceptions, for implicit, explicit, and remote access.

- (1) After the subscriber has spoken to the IP, and the IP has recognized the phrase, the IP signals the DMS that it is ready to dial. This is the same for an implicit, explicit, or remote connection.
- (2) The IP sends an inverted wink signal to the DMS. This inverted wink is termed the IP-Dial inverted wink.
- (3) An IP-Dial inverted wink is from 60-210 msec; however, the state changes are inverted (i.e. a normal wink is a state change from onhook to offhook, and back to onhook, while an inverted wink is a state change from offhook to onhook, and back to offhook.)
- (4) Once the inverted IP-Dial wink is received by the DMS, the subscriber is put on hold¹ and a UTR is attached to the trunk. If no UTR is available, the trunk connection is dropped, and the subscriber receives treatment.
- (5) If a UTR is attached successfully, an inverted wink signal is outputted from the DMS to the IP over the NFA trunk. This inverted wink is termed the UTR inverted wink with a default value of 150 msec.
- (6) The IP then sends DTMF digits to the DMS. The recommended digit pulse duration is 50 milliseconds on, followed by 50 milliseconds of no transmission, for a total of 100 milliseconds per digit. Digit duration is specified in trunk datafill. End of digits is specified by an inter-digital time-out (as specified in the trunk datafill) or by a '#' digit. Once end of digits indication has been obtained, the DMS to IP NFA trunk connection is dropped, the subscriber is removed from hold, and the call proceeds.
- (7) The digits are dialed for the subscriber as if he had dialed those digits himself. If the subscriber goes onhook while the IP is outputting digits, then the trunk is released at that point, and any digits received are discarded.
- (8) The IP may dial any directory number. In the case of implicit or explicit access, the IP may also dial a feature access code. This includes one of the SAID feature access codes discussed previously. For some features, the IP may dial both a feature access code and digits needed by the feature in one string. This is discussed in 1.8 "Digit Stringing" on page 14. The maximum number of digits that the IP may dial is the same as that of the subscriber. The maximum number of digits that this feature will support for IP dialing is 24.
- (9) After dialing, the IP releases the NFA trunk. The NFA feature is no longer active on the call unless extended DTMF conversion is taking place.

The IP may dial only a single string of digits, consisting of one feature access code or one routable directory number.

1. (On an Explicit access, this ends DP/DTMF conversion if the subscriber has basic, not extended conversion)

1.6 Combination of Implicit/Explicit/Remote Access

A subscriber line may have implicit, explicit, and remote access. If Implicit access is assigned and active, whenever the subscriber goes offhook, he is implicitly connected to the IP. If he then manually dials an explicit access code, the implicit connection is dropped after the first digit is entered, but then an explicit connection is established after the digits are translated. Depending on the customer group and translations datafill, these two connections may be over the same trunk group (possibly even over the same trunk member), or over different trunk groups. Such a connection is initiated by the subscriber voice dialing an explicit feature access code.

A subscriber can connect with explicit access, and then voice dial to be connected again with another explicit access. This gives the end office the option of having two flavors of explicit access, using different trunk groups, for example.

1.7 INTERACTIONS

1.7.0.1 Explicit or Remote Access on 2nd Leg of a Call

SAID allows a subscriber to hook flash while connected to the IP in order to access flash features. This allows the subscriber to place either an explicit or remote NFA trunk connection on hold while activating another DMS feature, such as call waiting or three way calling. While the IP is on hold, the DMS will not recognize any signaling from the IP on the NFA trunk other than an onhook.

A subscriber can place an NFA trunk connection on hold if:

- (1) He has been assigned flash capabilities.
- (2) He has accessed SAID with an explicit or remote connection from a line on the same switch as his home telephone line (local remote access.)

These requirements met, the subscriber may elect to enter a flash from his telephone set in order to invoke another feature. The result of the flash depends on the functionality of the other features which have been assigned to the subscriber's line. One the following actions takes place:

- (1) If the result of the flash is to place the NFA trunk connection on hold, then this occurs and the flash is propagated to the IP as an inverted wink of 500 milliseconds duration. This can occur, for example, if the subscriber is connected to the IP and flashes to initiate the second leg of a three way call. While the NFA trunk connection is on hold, the DMS will ignore any inverted winks which it receives on the trunk. The only signaling which the DMS will recognize from the NFA trunk is an onhook. If an onhook is received, the NFA trunk will be idled and that leg of the call will be disconnected. An AMA record will be generated, if datafilled, to record the connection to the NFA trunk.
- (2) If the result of the flash is to remove the NFA trunk connection from hold, then this will occur and the trunk will be reconnected to the call. For example, this can occur if the subscriber has placed the NFA trunk on hold so that call waiting could be activated and now wishes to reconnect to the first call leg with the IP. Whenever the result of the flash is to remove the NFA trunk from hold, the flash will be propagated on the NFA trunk to the IP as an inverted wink of 500 msec duration.

- (3) If the result of the flash is to drop the connection to the NFA trunk, then the leg of the call with the NFA trunk will be disconnected. For example, this can occur if the subscriber has an active three way call in progress with the NFA trunk on the second leg and flashes to disconnect the second leg. When this occurs, an onhook will be sent on the NFA trunk to the IP. An AMA record will be generated, if datafilled, to record the connection to the NFA trunk.
- (4) If the subscriber completes the first leg of a call, and then flashes, and dials the explicit SAID feature access code. then the subscriber can flash back to the first leg of the call as soon as the DMS has seized the trunk connection to the IP on the second leg. The subscriber is not required to wait for the DMS to create a speech path from the subscriber to the IP. This functionality only applies if the first party is not an NFA trunk, because a single subscriber may not conference two NFA connections together.
- (5) If the NFA trunk connection is a remote access to a different office than the one which serves the originator (remote remote access), then a flash will not be propagated on the NFA trunk to the IP. This is because the flash from the originating office is not propagated through the network to the SAID office. In this scenario, the NFA trunk will not be aware that the originator has flashed.

1.7.0.2 Restrictions- 2nd Leg of a Call

- (1) The subscriber will not be allowed to place an implicit NFA trunk connection to the IP on hold.
- (2) Normal three-way calling functionality will apply to the interactions between three way calling and NFA trunk connections with the following exceptions:
 - (a) A single subscriber will not be allowed to conference together more than one connection to an NFA trunk. If an attempt is made to do so, the second NFA trunk connection will be dropped. However, it could be possible for two NFA trunk connections to be active on a particular call if call chaining is active or if either of the NFA connections is a remote access to an NFA trunk in another office.
 - (b) A subscriber can establish a call which includes two explicit or remote NFA trunk connections through the use of call chaining. For example, if line A and line B both have NFA and three way calling, it is possible for line A to call line B. This can be followed by both lines A and B adding an explicit NFA connection to their respective second call legs. When A and B are conferenced together, the call chain will include two NFA trunk connections.
 - (c) A subscriber can establish a call which includes remote NFA trunk connections if either of the connections is a remote access to an NFA trunk in another office. For example, line A dials an explicit NFA connection and flashes to place the connection on hold. He then dials an NFRA DISA number in another office and enters a valid DN and PIN combination to establish a remote connection. At this point, he can flash and form a three-way call between the two trunk connections.

- (4) If the NFA trunk connection is a remote access to a different office than the one which serves the originator (remote remote access), then a flash will not be propagated on the NFA trunk to the IP. This is due to the fact that the flash from the originating office is not propagated through the network to the SAID office. In this scenario, the NFA trunk will not be aware that the originator has flashed.
- (5) Call Transfer:
- (a) A subscriber is not allowed to transfer an NFA trunk connection from one party to another. This applies to three way calling as well as to any other features which allow a call to be transferred.
- (b) A subscriber can transfer a remote NFA connection to a different office than that of the subscriber. For example, party A forms a three way call between party B and a remote NFA connection in a different office. The remote NFA connection was established by dialing an NFRA DISA DN associated with an office other than party A's office. If party A has been assigned call transfer capabilities, he can transfer party B to the remote NFA connection. The AMA records generated for any calls which are extended by the remote NFA connection will use the DN associated with the PIN used to establish the connection as the originating DN.

1.8 Digit Stringing

Some features require the subscriber to enter digits after the feature is activated. For example, call forward prompts for a number to use as a forwarding destination. The SAID feature Stringing of Digits, to be released in 1994 in a post-BCS36 software release, allows the IP to send in multiple digit strings for features described below.

Table 1 Supported features for NFA stringing of Digits

Feature Name
Cancel Call Waiting
Call Forward Programming
Call Request Delete Specific
Directed Call Pickup Barge In
Directed Call Pickup
Directed Call Park (store)
Call Park (retrieve)
Authorization/Account Code Dialing
Loudspeaker Paging Answerback
Calling Name and Number Blocking
Speed Call Programming

The first digit string must be a feature access code for one of the DMS features allowed under stringing of digits. The second digit string consists of digits which are processed by the feature which is activated by the first digit string. The second digit string can not be a feature access code. The digits from the second digit string are processed by the activated feature as if the subscriber had manually entered the digits from his telephone set.

For example, if the IP allows a subscriber to voice dial call forward Mom, then the IP would send the DMS the feature access code and Mom's phone number.

The feature access code and dn may be separated by a DTMF A, with a low frequency of 697 Hz and a high frequency of 1633 Hz. If ambiguous feature access codes are used, the separator must be used. The digit string must be terminated by an octothorpe (#) as usual.

NFA stringing of digits will not alter the functionality of the supported features. As digits are processed, normal call processing tones may be heard.

1.9 SAID Hardware Characteristics

1.9.1 SAID NFA Trunk Characteristics

1.9.1.1 The NFA Trunk Type

- (1) Though it is implemented as a two way trunk, no origination is allowed from this trunk. Any origination from this trunk puts it in lockout state. This trunk can carry inverted winks.
- (2) By allowing this trunk to be two way type, parameters like inpulsing start signal, inpulsing digit signaling, interdigital time-out etc. can be datafilled.
- (3) The NFA trunk group to be used by subscribers is controlled via translations datafill.
- (4) When IP is dialing for a subscriber, an octothorpe (# digit) or interdigital time-out indicates end of digit inpulsing. The IP may not indicate end of digits by simply going onhook. Normally, the IP should not go onhook until after the DMS drops the trunk connection. If the DMS has not dropped the trunk connection within two seconds following the # digit or the end of the interdigital time-out, the IP may then go onhook, if desired. Under normal conditions, however, the DMS should disconnect the trunk within that two second period
- (5) The NFA trunk is restricted to immediate start outputting and wink start inpulsing.
- (6) The NFA trunk is supported only on UTR equipped DTC or LTC. The DMS peripheral must use UTRs for digit collection from the trunk. In the SAID Line and Trunks Enhancement feature, to be delivered in 1994, the DTCI peripheral will also be supported.
- (7) NFA trunks must be digital.
- (8) NFA trunks must be two-way with digitone (DT) pulsing.
- (9) NFA trunks must use a wink (WK) for the incoming start dial signal and immediate (IM) for the outgoing start dial signal.
- (10) The IP may dial the maximum number of digits for the subscriber which he could dial himself, as a single digit string. In BCS36, this maximum is set to 24 digits. The '#' digit, used as an end of digits indication, it is not included in this count.
- (11) The SELSEQ field in table TRKGRP should not be datafilled to values ASEQ (Sequential) or DSEQ (Desequential) for any NFA trunks which may serve implicit connections. If the trunk is only being used for explicit connections, then this restriction does not apply.

1.9.1.2 Trunk Timing Parameters

Customer offices can change call setup timing via four office parameters. A restart is not required to activate changes to the values of these parameters.

The recommended value of these parameters is their default value. Decreasing the value of these parameters can impact the grade of service for NFA customers but will speed up connection time. These parameters should not be decreased unless the intelligent peripheral and transmission medium used to connect the IP to the DMS are capable of supporting lower values.

- (1) Length of the pre-dial delay on NFA trunks: The default value is 15 (between 140-150 ms.) The range for this value is between 0-150 ms. Note: this range changes to 0-64 which is 0-640 msec in NA004.
- (2) Length of the answer filter time on NFA trunks: The range of this value is between 60-90 ms. The default value is 9 (between 80-90ms.)
- (3) Length of the inverted wink which is sent by the DMS on the NFA trunk when the speech path is established between the subscriber and the NFA trunk (cut-through inverted wink): The range of this value is between 50-100 ms. The default value is 10 (between 90-100 ms.)
- (4) Length of the inverted wink which is sent by the DMS on the NFA trunk when the DMS has attached a UTR and is ready to receive digits over the NFA trunk (UTR inverted wink): The range of this value is from 0 to 2550 milliseconds. The default value is 15 (140-150 milliseconds.)
- (5) The IP sends one wink to the DMS to signal that the IP is ready to dial for the subscriber is termed the IP-Dial inverted wink. The DMS expects a value between 60-210 milliseconds.

Figure 1 - Implicit Connection, Subscriber Dials the Call

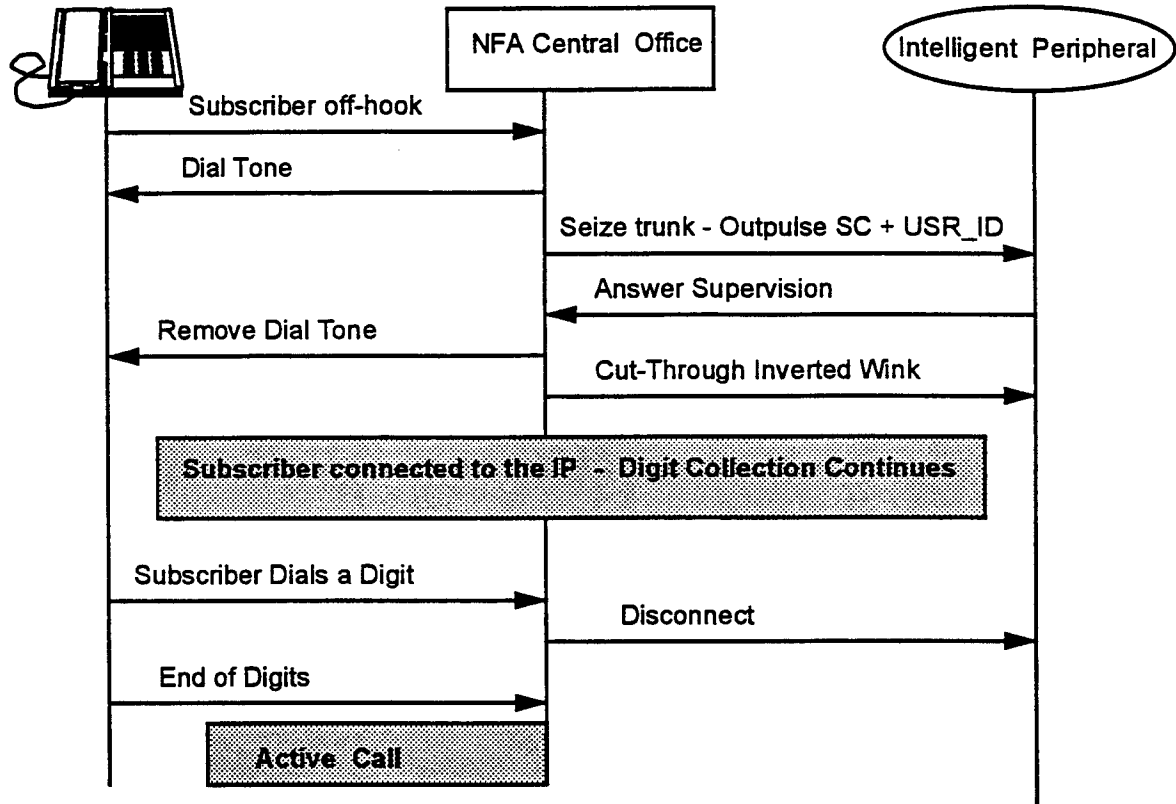

Figure 2 - Implicit Connection, IP Dials the Call

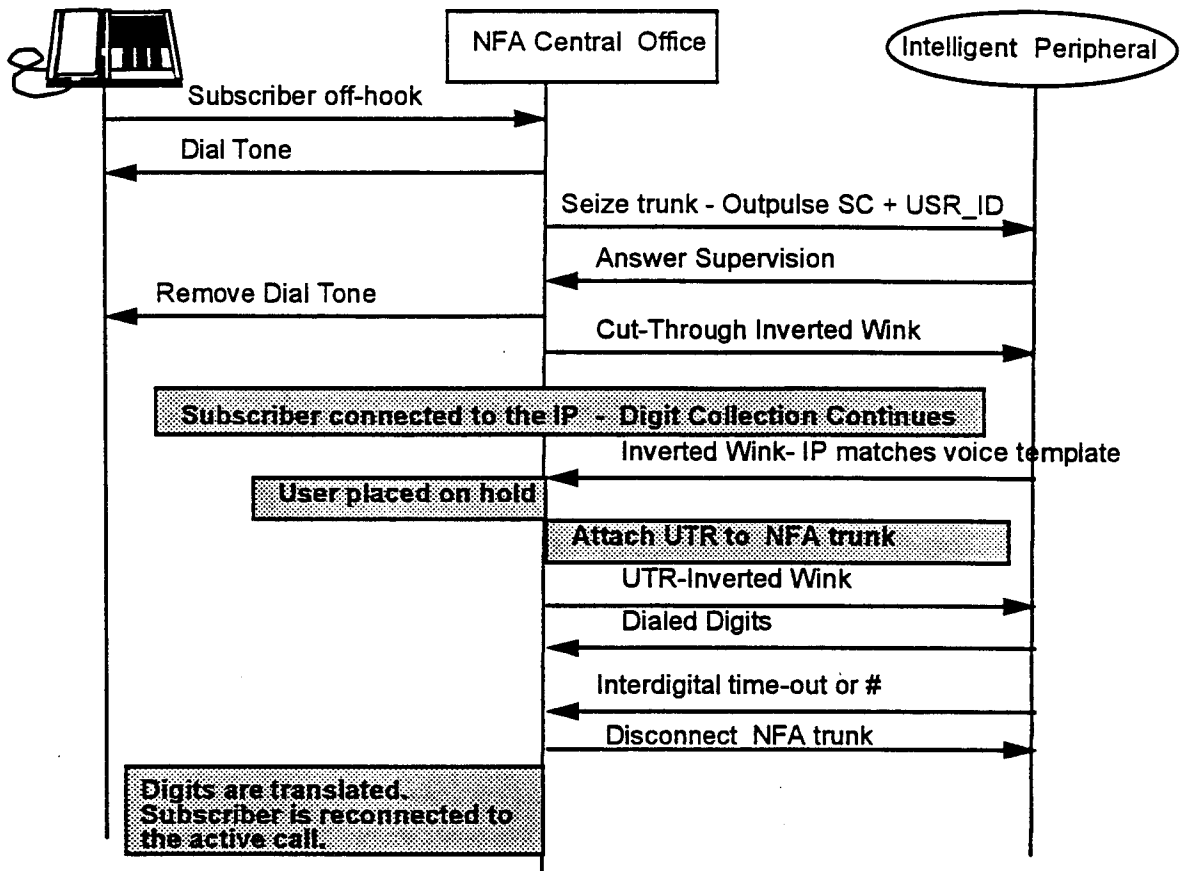

Figure 3 - Explicit connection, Basic DP/DTMF Conversion Performed

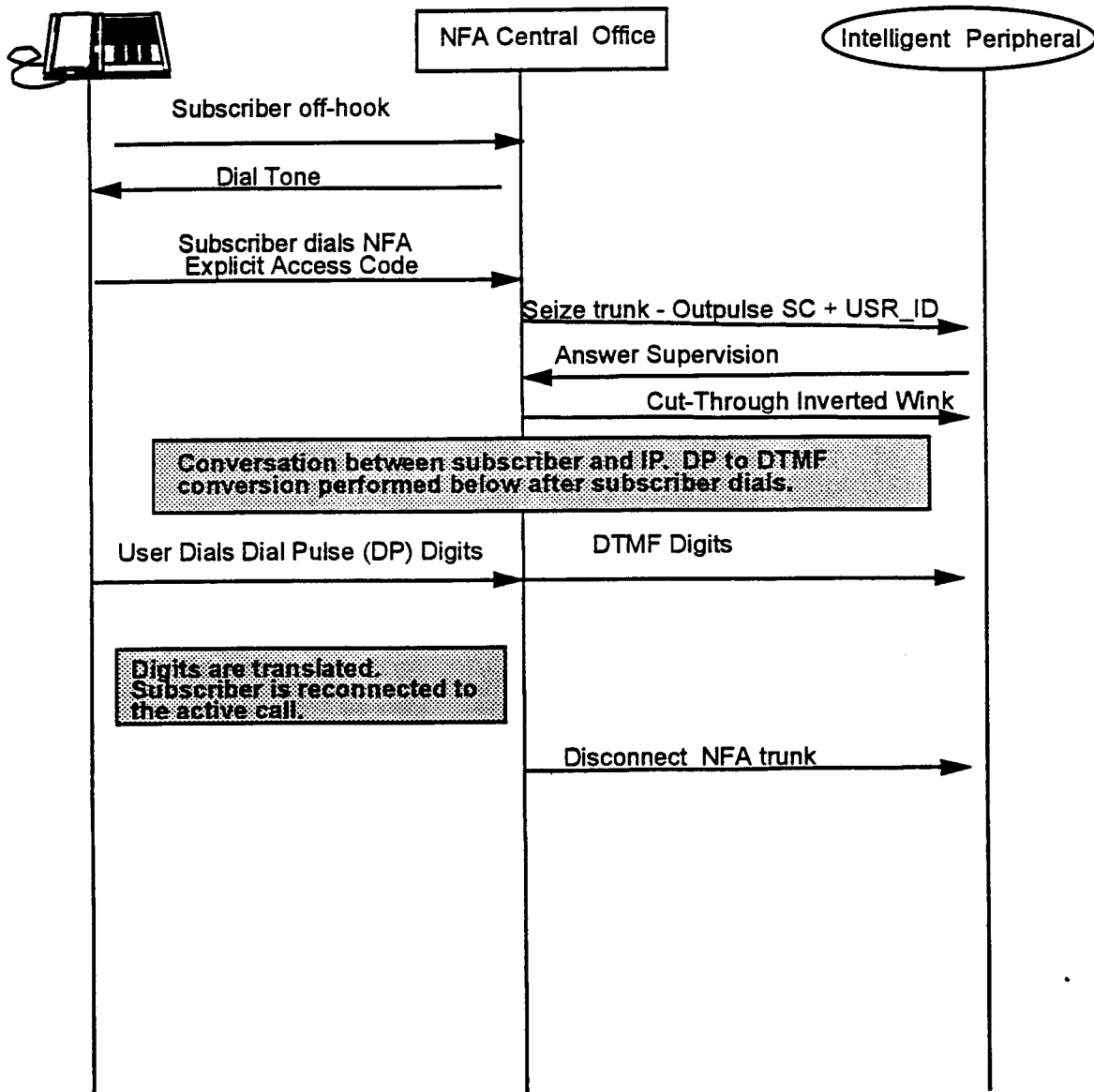

Figure 4 - Implicit Connection Followed by Explicit Connection

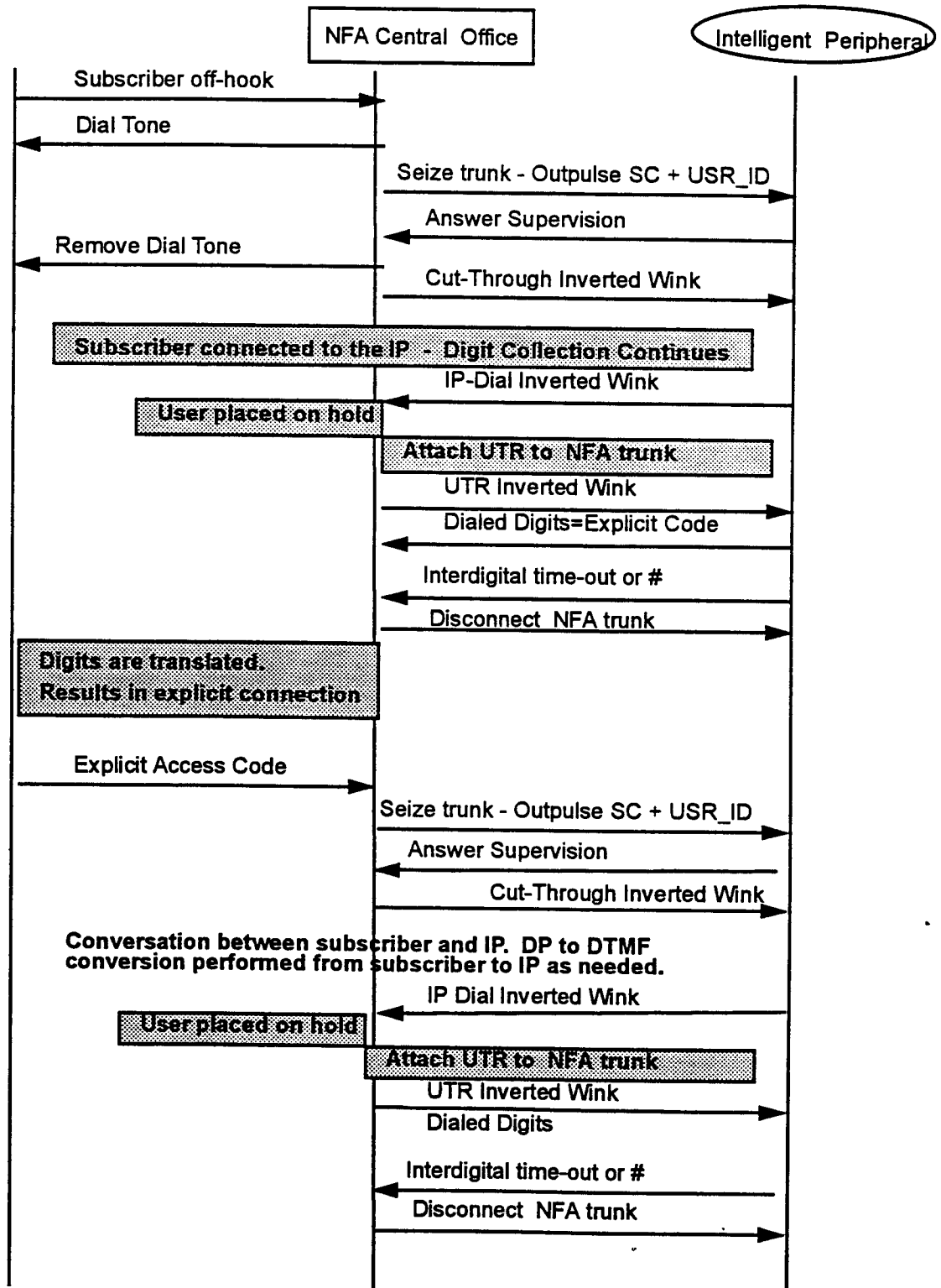

Figure 5 - IP dialing SAID Explicit Feature Access Code

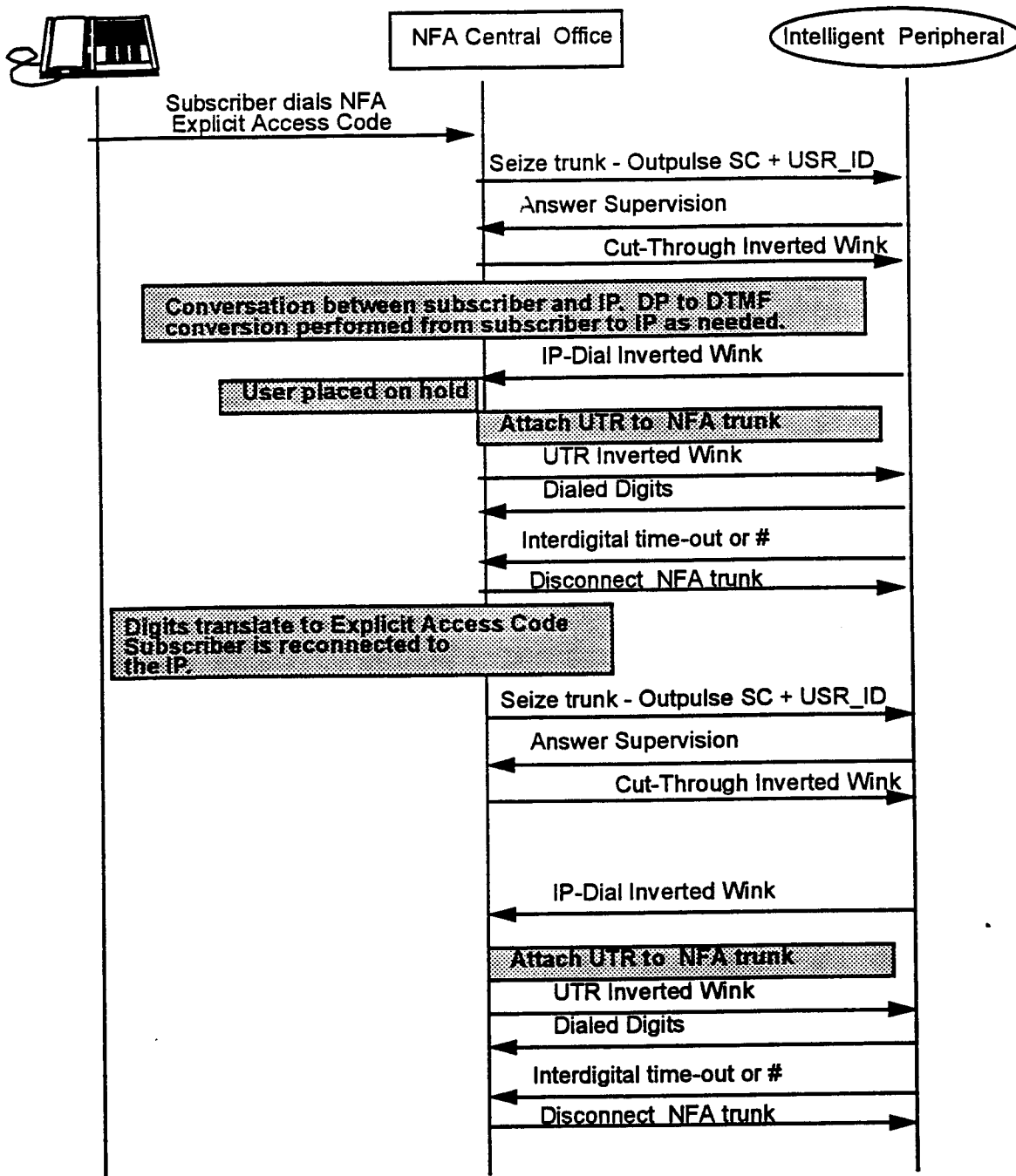

Figure 6- Remote Access with IP Dialing

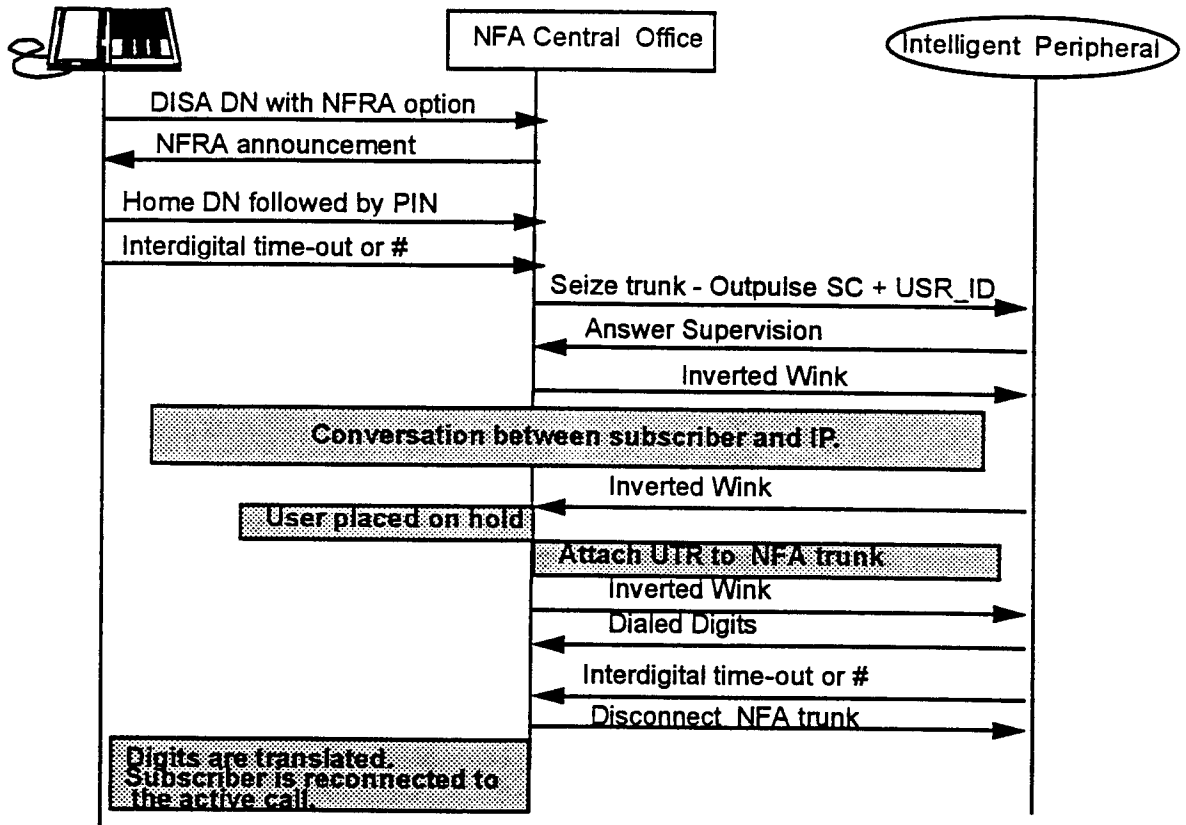

Figure 7 - Remote Access with IP Dialing, CFRA Present

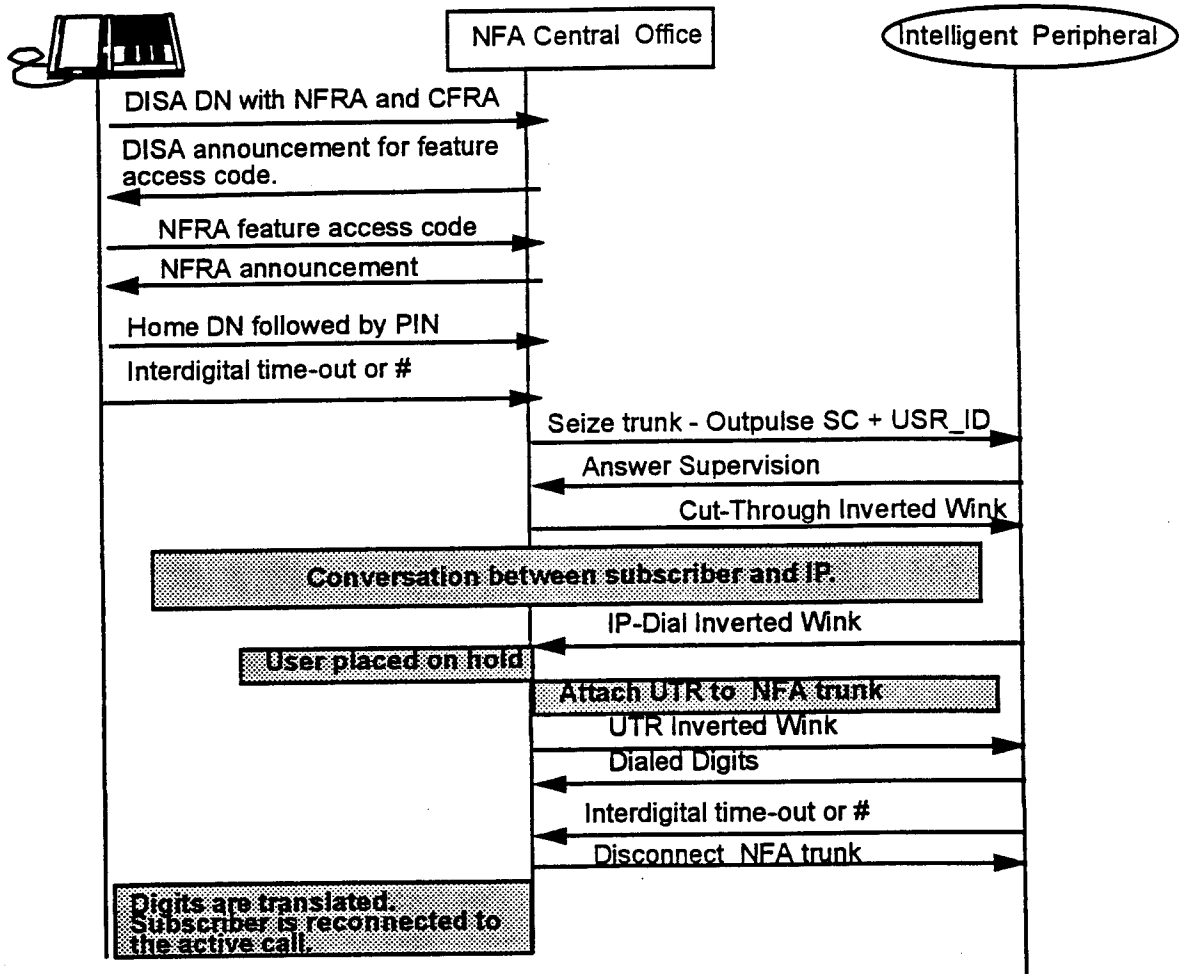

Figure 8 - Subscriber Flash Placing IP on Hold

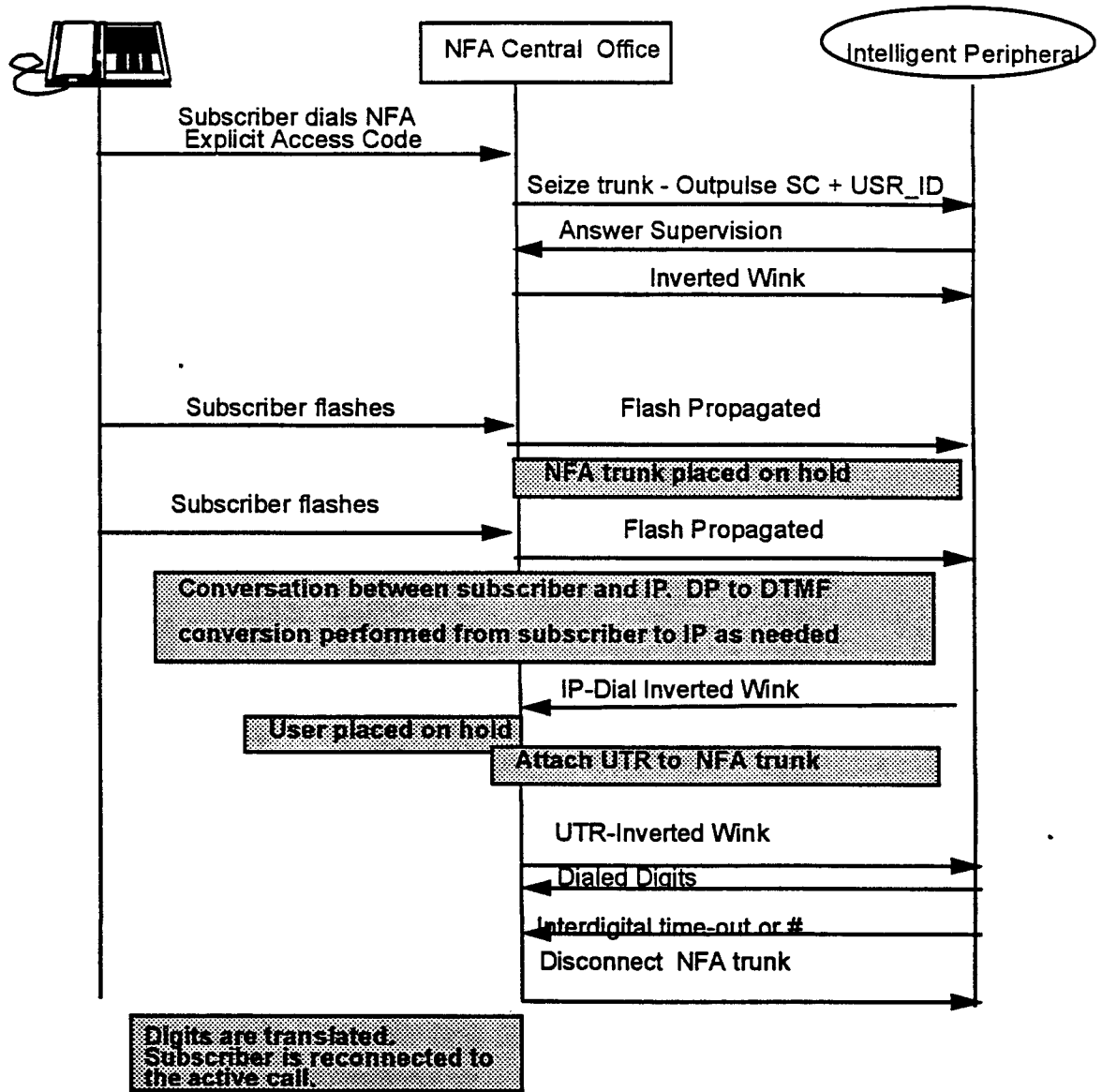
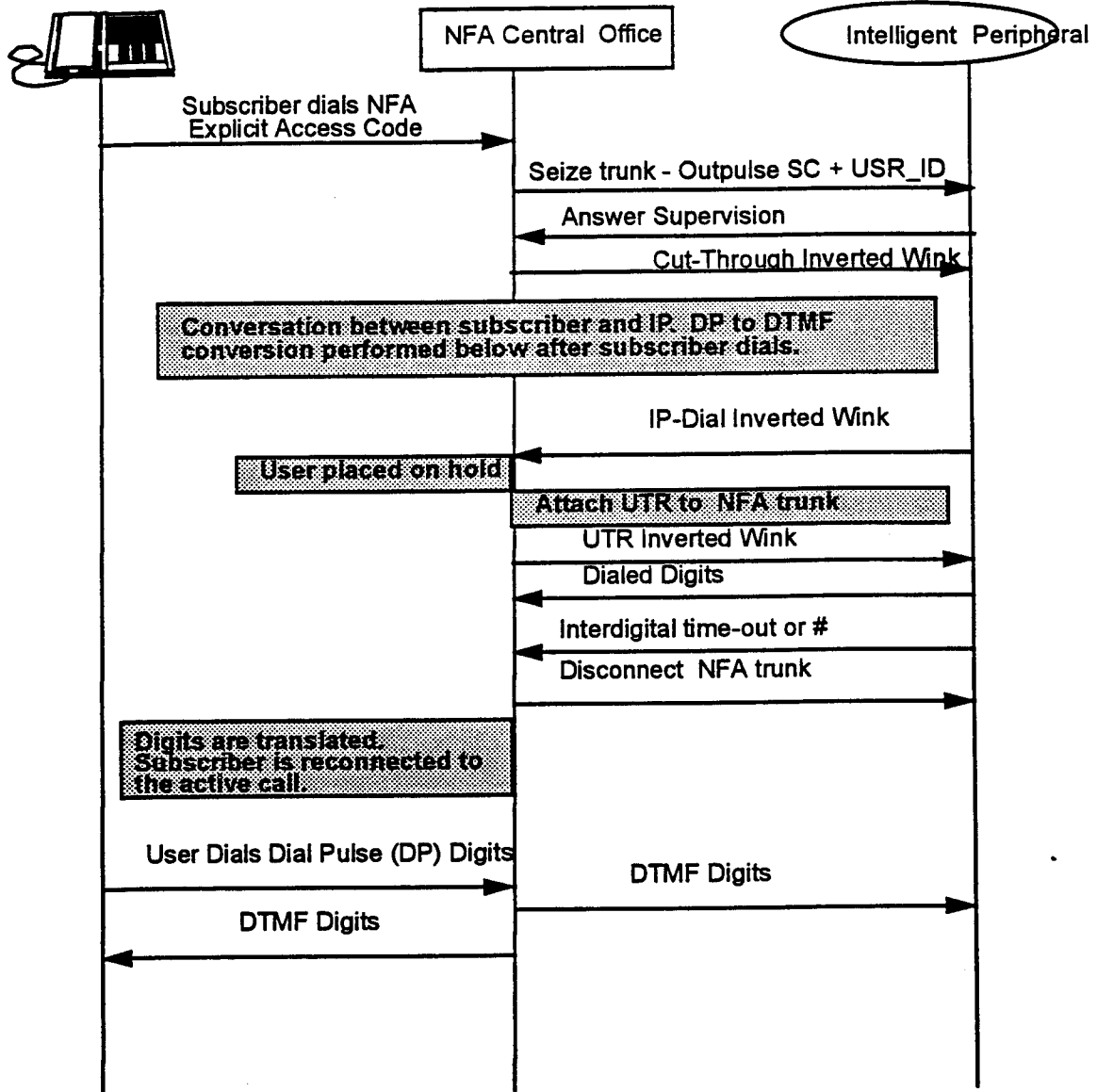

Figure 9 - Extended Conversion on an Explicit Connection



References

NTP 297-1001-316 DRAM Administration Guide

NTP 297-1001-451 Common Customer Data Schema

NTP 297-1001-527 DRAM Reference Manual

NTP 297-5161-350 Advanced Intelligent Network Translations Guide

Glossary of Abbreviations

ANI Automatic Number Identification
CLLI Common Language Location Identifier
CFRA Call Forward Remote Access
CPE Customer Premises Equipment
DISA Direct Inward System Access
DLH Distributed Line Hunt
DN Directory Number
DP Dial Pulse
DRAM Digital Recorded Announcement Machine
DTC Digital Trunk Controller
DTMF Dual-Tone MultiFrequency
IBN Integrated Business Network
IP Intelligent Processor
LGC Line Group Controller
MLH Multiple Line Hunt
LSSGRLATA Switching System Generic Requirements
LTC Line Trunk Controller
NFA Network Facility Access
NFRA Network Facility Remote Access
PIN Personal Identification Number
RCC Remote Cluster Controller
RES Residential
SAID Speech Activated Intelligent Dialing
SLC Subscriber Line Carrier
SMS Subscriber Module SLC-96
SMU Subscriber Module Urban
TRKGRP Trunk Group table
TRKMEM Trunk Member table
TRKSGRP Trunk Subgroup table
UTR Universal Tone Receiver

SAID

NIS #Q225-1

DMS-100 Family

Speech Activated Intelligent Dialing

SAID

(NTXR25AA)

**Northern Telecom Interface Specification
for DMS Network Interface Access to Intelligent
Peripherals, Volume 2**

Version 1.1 February 1995

Feature Description - SAID

Switch Provides

- * Implicit, Explicit, Remote connections
- * Connection after flash
- * DP to DTMF conversion
- * Two AMA call codes
- * One AMA module code

IP Trunk Access

- * Immediate start dial
- * DTMF signalling
- * Two-way transmission
- * IP dialing for the subscriber

RES./IBN Line Access

- * Standard DTMF or DP phones

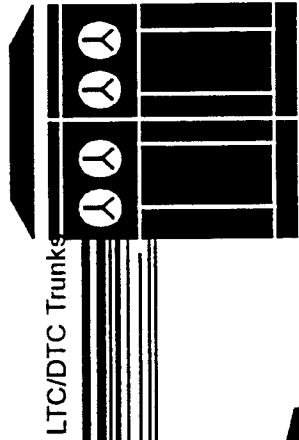
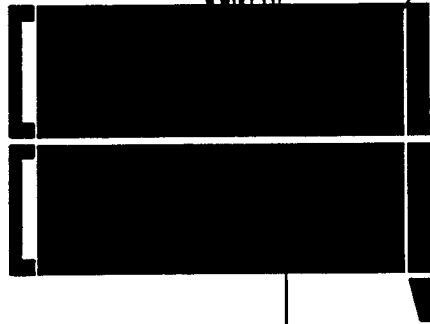
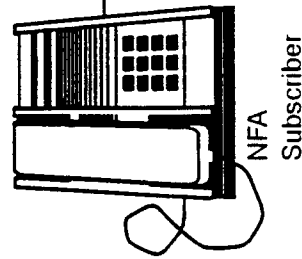

Intelligent Peripheral

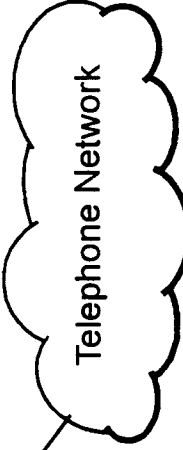

Network Access

- * IP dialed digits are routed via the subscriber's dialing plan

BCS35 Feature Description

SAID

DMS to IP
NFA Trunk Timing Diagram

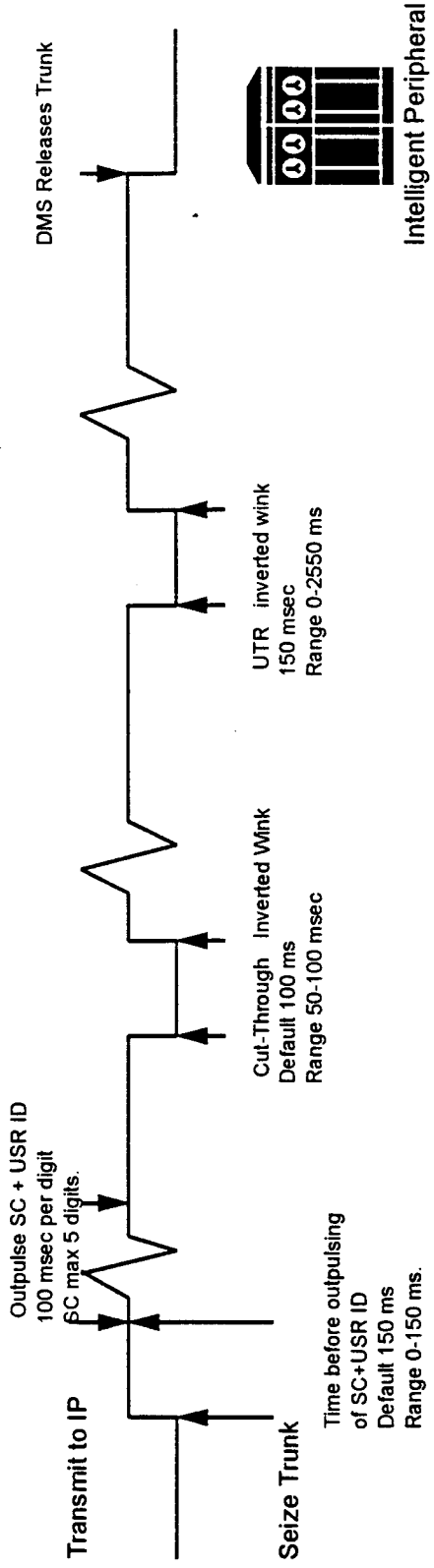

Time before outpulsing
of SC+USR ID
Default 150 ms
Range 0-150 ms.

Note: in NA004 the
range is 0-640 msec.

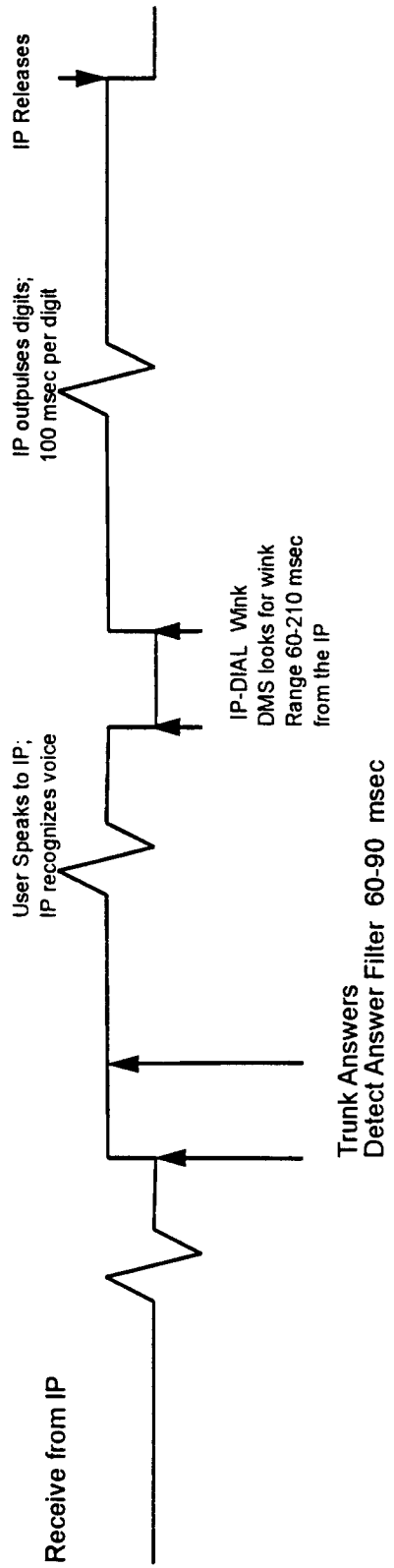

SAID

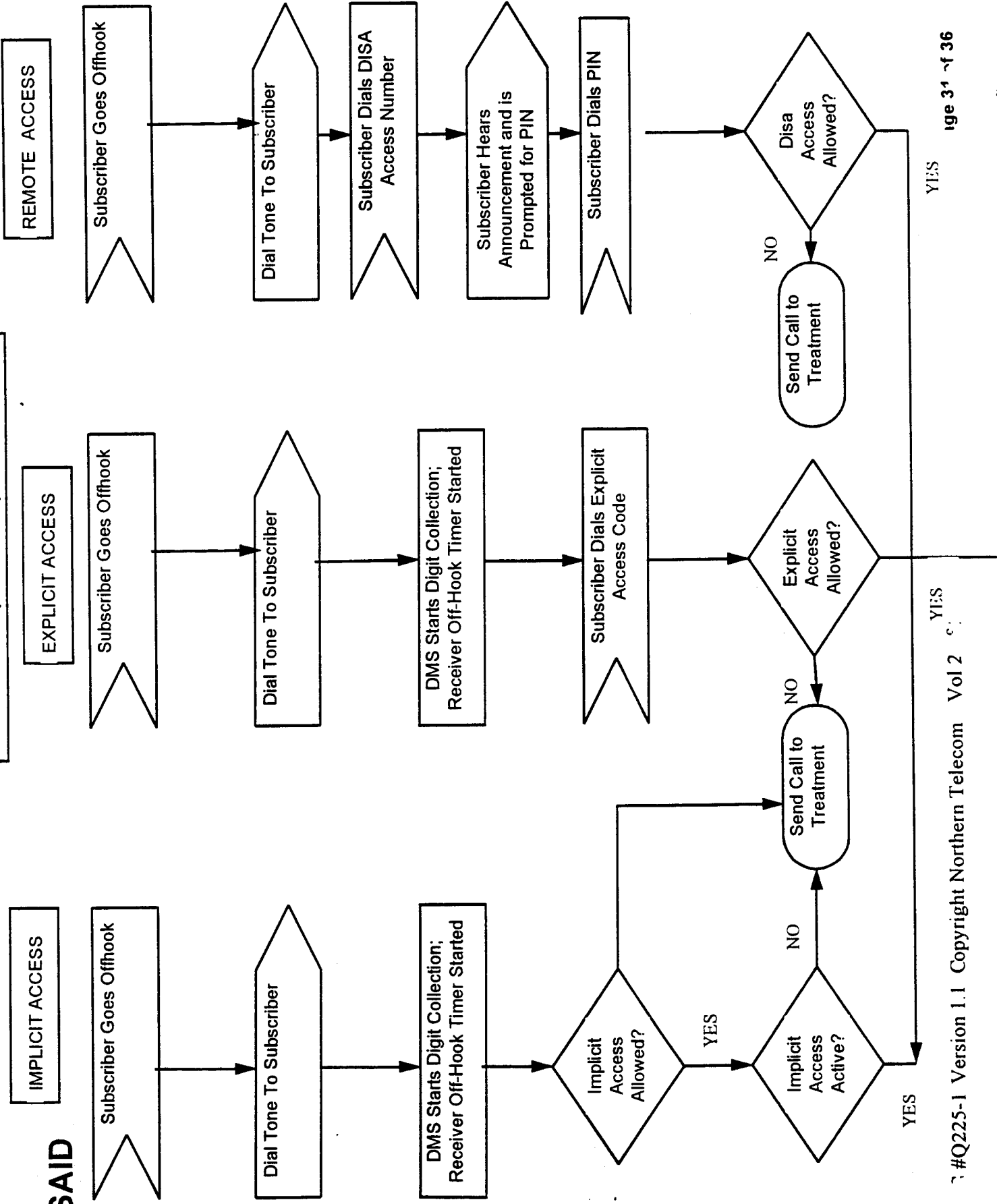

SAID

If the user dials digits during an implicit access at any time up until the point that the IP signals that it is ready to dial for the user, then the NFA trunk is released and the user can dial normally.

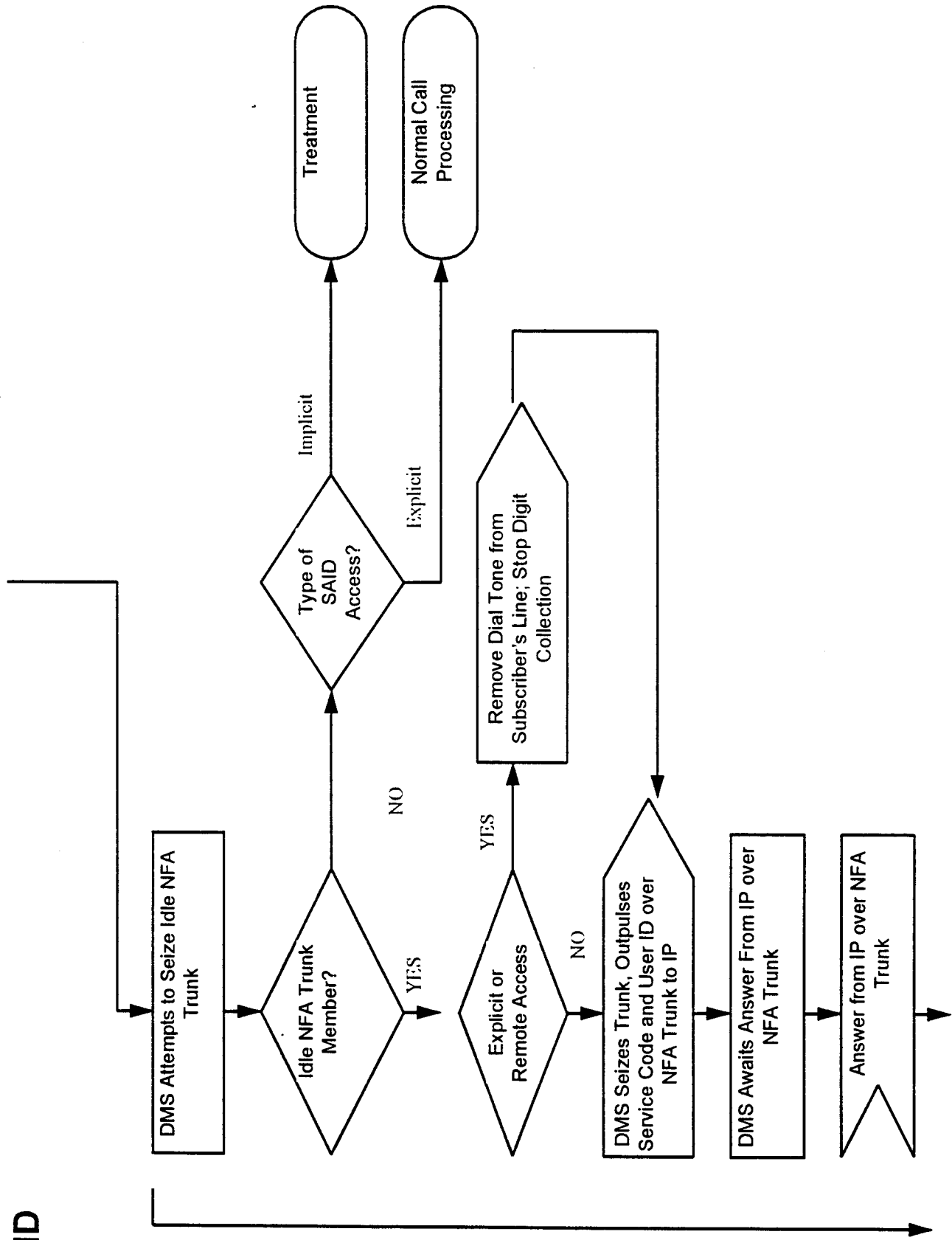

SAID

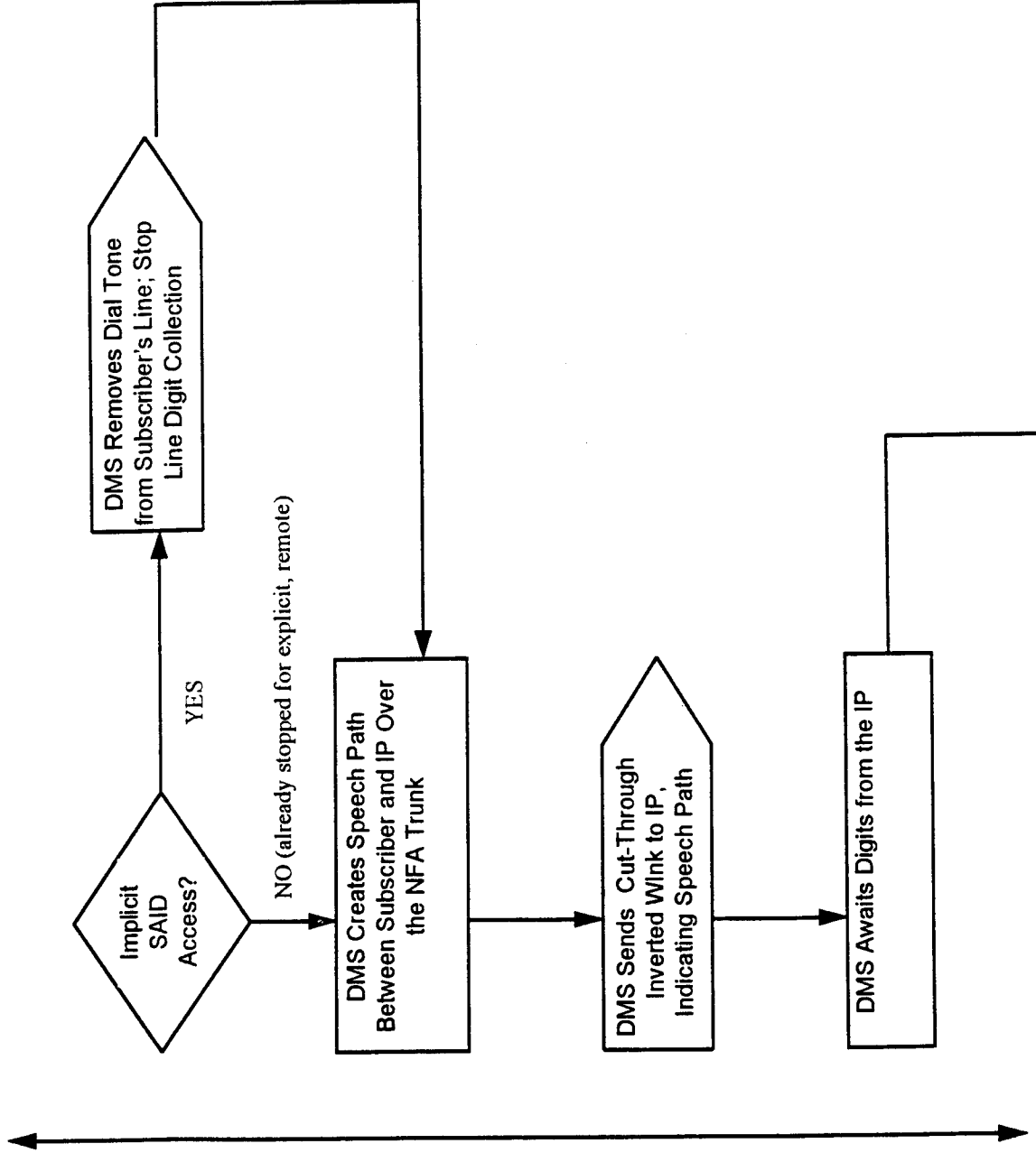

SAID

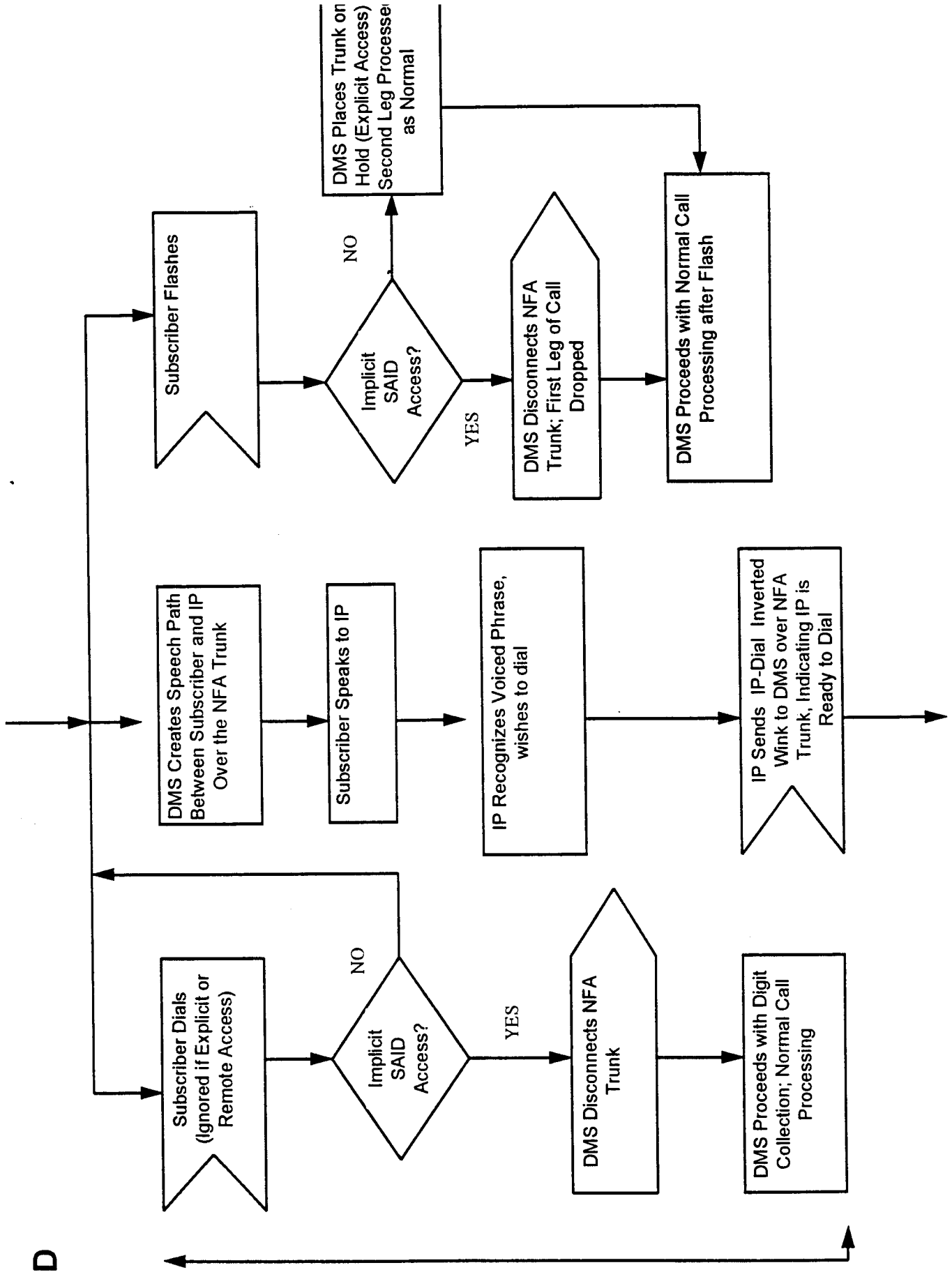

SAID

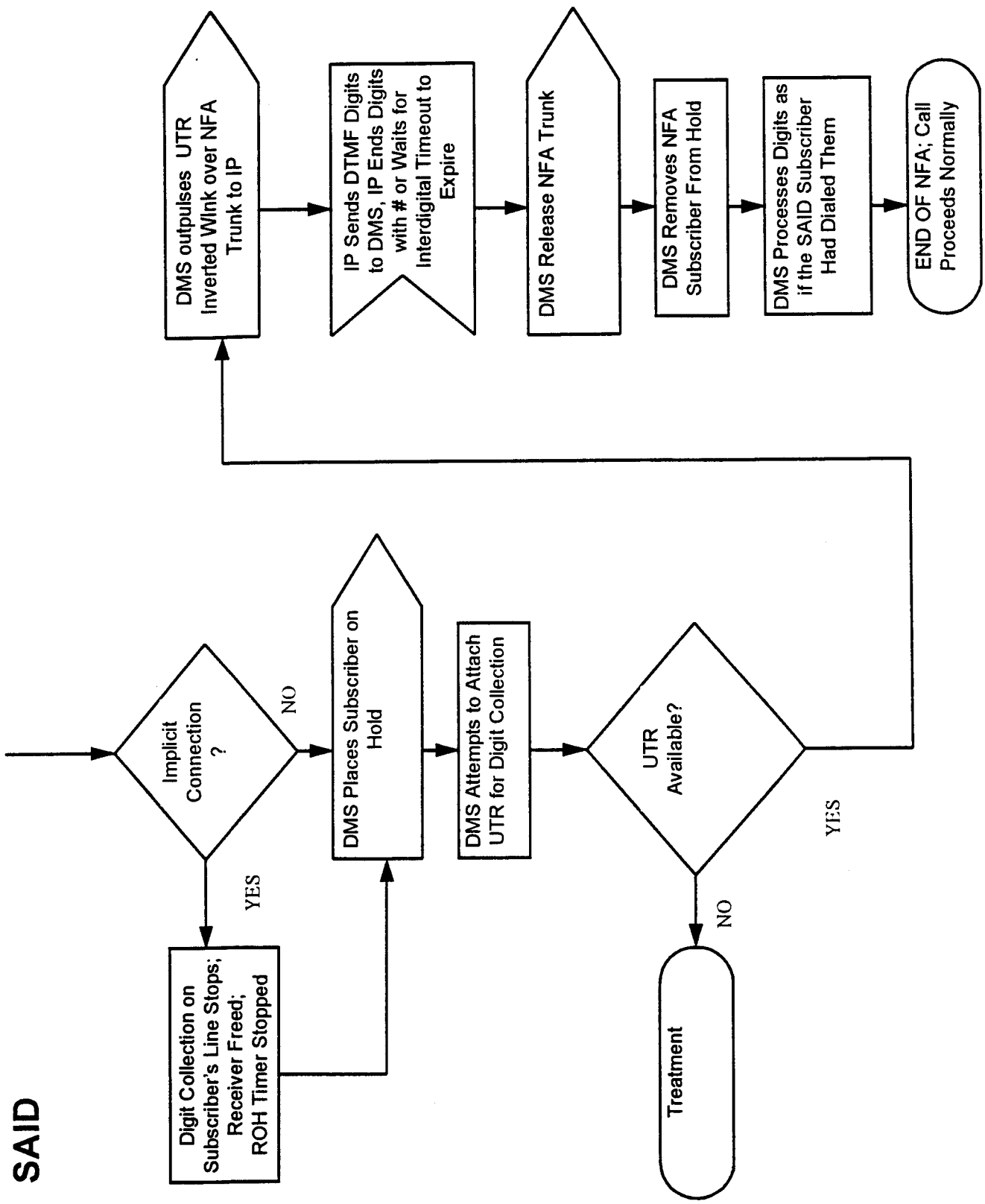

SAID

